

DO NOT SCALE DRAWING

IF IN DOUBT - ASK

3rd ANGLE PROJECTION

DRAWING NUMBER

PPMINITC0500BB-CD

ISSUE	DESCRIPTION	DATE
B	BS & PATENT DETAIL ADDED	24/05/05

PATENT PENDING GB 0509362.0
 PATENT PENDING US 11/053657
 PATENT PENDING EEC 05075275.7

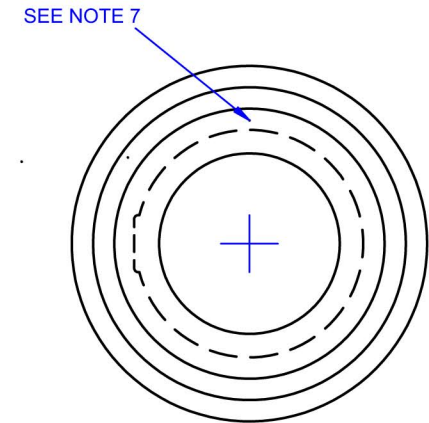
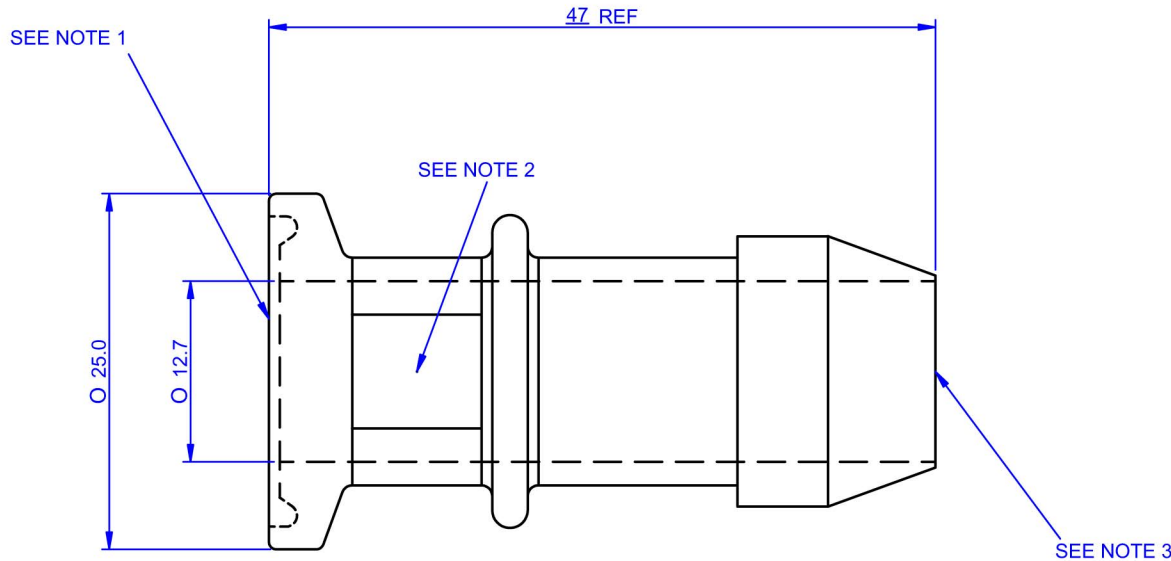

NOTES:

1. THIS FACE TO BE FLAT TO 0.15 mm. MAXIMUM EJECTOR WITNESS PERMISSABLE 0.07mm.
2. BATCH CODE TO BE MOULDED ON PART IN THIS AREA.
3. NO FLASH OR IMPERFECTION PERMISSABLE ON FRONT EDGE OF MOULDING.
4. NO CONTAMINATION ALLOWED.
5. MAXIMUM SPLIT LINE FLASH 0.2 mm.
6. PART TO BE MANUFACTURED IN CLEANROOM ENVIROMENT.
7. INJECTION GATE MARK TO BE TRIMMED FLUSH.

© COPYRIGHT

This drawing and its associated design is the property of Bio-Pure Technology Ltd & may not be copied or used for any purpose other than that for which it is supplied, without the express written authority of Bio-Pure Technology Ltd

DIMENSIONS IN MILLIMETERS

TOLERANCES UNLESS STATED
 0 DEC PLACE +/- 0.5
 1 DEC PLACE +/- 0.25
 2 DEC PLACES +/- 0.10

ANGULAR +/- 0.5 DEG

MATERIAL AND SPECIFICATION

PP Natural
 Borealis HD810MO

DRAWN BY

MJF

CHECKED BY

PRW

DATE

29/11/04

APPROVED BY

RW

FINISH

CLEAN

SCALE

2:1



BioPure Technology Ltd,
 Unit M1, Hazleton Interchange,
 Lakesmere Road, Horndean, PO8 9JU.
 Tel: +44 (0) 2392 499000
 Fax: +44 (0) 2392 499001
 Email: sales@biopuretech.com
 Web: www.biopuretech.com

TITLE

BIO-BARB
 SMALL FLANGE x 0.500

PART No:

PPMINITC0500BB