

DO NOT SCALE DRAWING

IF IN DOUBT - ASK

3rd ANGLE PROJECTION 

DRAWING NUMBER

PP0750BY-CD

ISSUE	DESCRIPTION	DATE
1	INITIAL DRAWING	26/04/05

PATENT PENDING GB 0509362.0
 PATENT PENDING US 11/053657
 PATENT PENDING EEC 05075275.7

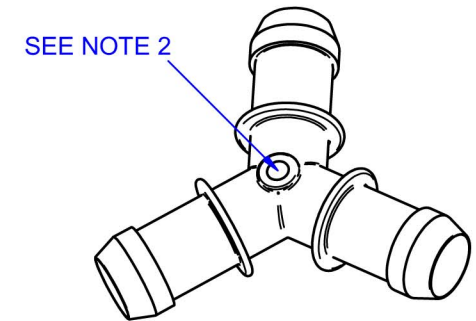
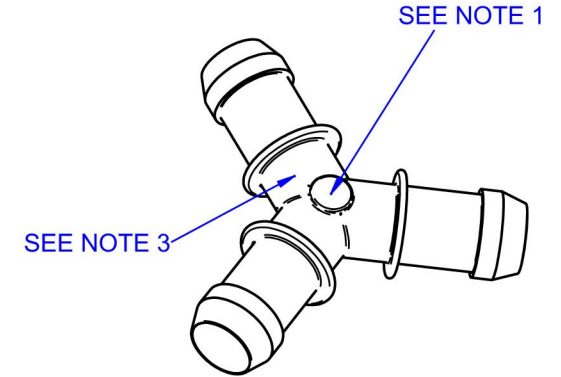
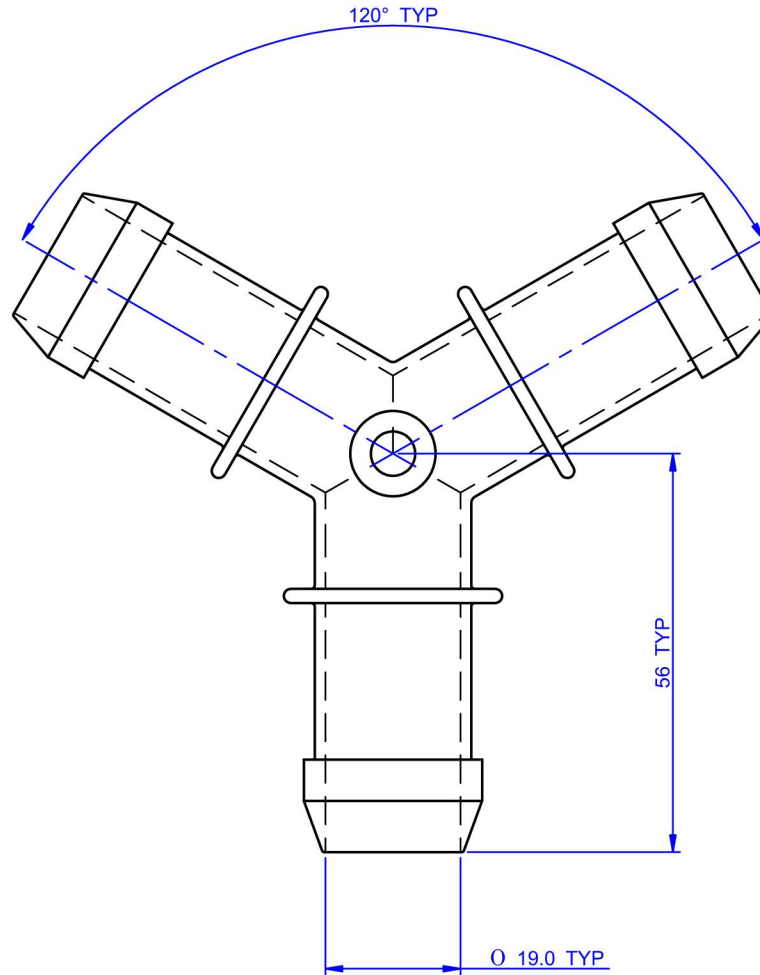
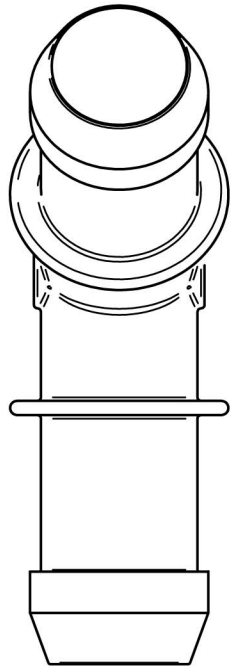

NOTES:

1. BATCH CODE TO BE MOULDED ON PART IN THIS AREA.
2. INJECTION FEED MARK TO BE FLUSH.
3. COMPONENT SIZE IDENTIFICATION TO MOULDED IN THIS POSITION.
4. NO FLASH OR IMPERFECTIONS PERMISSABLE ON FRONT EDGE OF SPOUTS.
5. NO FLASH PERMISSABLE ON INTERNAL CORE INTERSECTION.
6. NO CONTAMINATION ALLOWED.
7. PART TO BE MANUFACTURED IN CLEANROOM ENVIROMENT.

© COPYRIGHT

This drawing and its associated design is the property of Bio-Pure Technology Ltd & may not be copied or used for any purpose other than that for which it is supplied, without the express written authority of Bio-Pure Technology Ltd

DIMENSIONS IN MILLIMETERS

TOLERANCES UNLESS STATED
 0 DEC PLACE +/- 0.5
 1 DEC PLACE +/- 0.25
 2 DEC PLACES +/- 0.10

ANGULAR +/- 0.5 DEG

MATERIAL AND SPECIFICATION

PP Natural
 Borealis HD810MO

DRAWN BY

MJF

CHECKED BY

PR

DATE

26/04/05

APPROVED BY

RM

FINISH

CLEAN

SCALE

1:1



BioPure Technology Ltd,

Unit M1, Hazleton Interchange,
 Lakesmere Road, Horndean, PO8 9JU.
 Tel: +44 (0) 2392 499000
 Fax: +44 (0) 2392 499001
 Email: sales@biopuretech.com
 Web: www.biopuretech.com

TITLE

3/4" BIO Y CONNECTOR

PART No:

PP0750BY